

ENGLISH

# 2 WIRE INTERCOM SYSTEM

---

USER MANUAL



---

Please read this manual carefully before using the product, and keep it well.

# 1. Parts and Functions

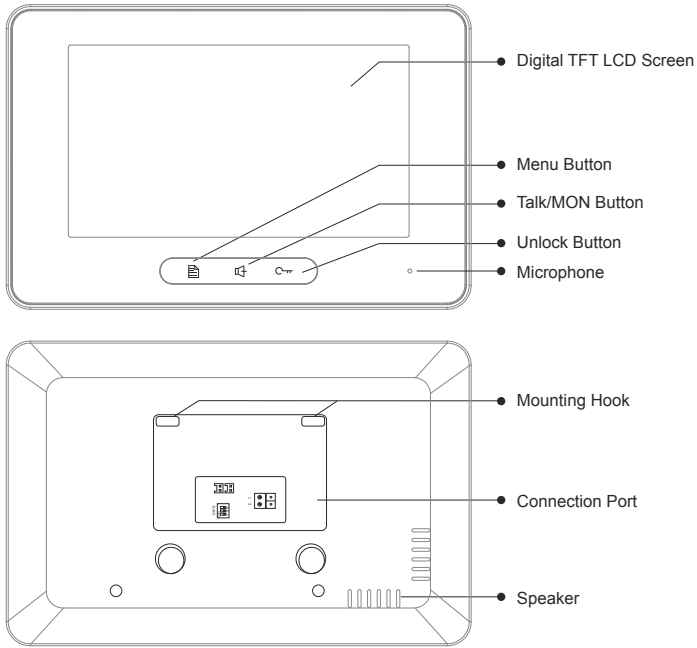

## Key functions

LCD screen	Display the visitors' image
Unlock button	Press to release the door
Menu button	Press to open the menu shortcuts
Talk/Mon button	Press to communicate hands free with visitor Press to view the outdoor condition in standby mode
Microphone	Receive voice from the user
Mounting hook	Use to hang up the monitor
Connection port	Bus terminal
Speaker	Send out voice from the visitor

## 2. Monitor Mounting

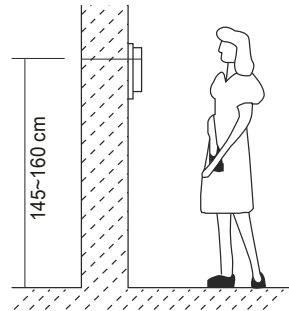
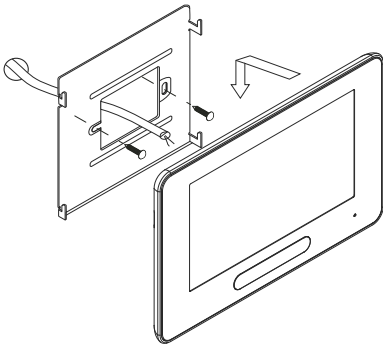











1. Use the screws to fix the Mounting Bracket on the mounting box.(fitting accessories includes a Bracket (Two pieces of 4X25 screws are needed for fastening the Mounting Bracket), Special 2 wire connectors to connect with Monitor)
2. Wire the system correctly(see the later connection chapter) then hang the Monitor on the Mounting Bracket firmly.

## 3. Main Menu

Touch the screen anywhere or touch  **Menu** button on monitor in standby mode, the main menu page will be shown as follows:



## 4. Basic Door Release Operation



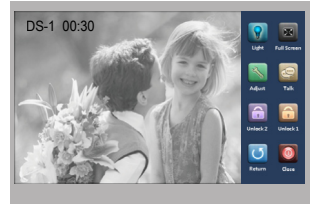



1. Press **CALL** button on outdoor station, the Monitor rings, at the same time, the screen displays the visitors' image.
2. Press  **TALK/MON** Button on monitor or touch  icon on screen, you can communicate hands free with the visitor for 90 seconds. After finishing communication, press  **TALK/MON** button again or touch  icon to end the communication. If nobody answers the phone, the screen will be turned off automatically after 30 seconds.
3. During talking state, Press  **UNLOCK** Button or touch  icon to open the door for the visitor. (if two locks are connected to door camera, touch  **unlock 2nd** icon to release the second lock )
4. When the monitor is in standby mode, press  **TALK/MON** button (or touch  **Monitor** item on main menu page), The screen can display the view of outside. Or touch  **Manual Monitor** icon on main menu to get into the door camera switching mode, if multi door stations are installed, you can press the door 1/2/3/4 to monitor the door station or CCTV camera you want. press **Home** icon to exit and enter main menu page.



Note: if the system connect 2 wire camera via camera controller, press the camera 1/2/3/4 to monitor the camera you want. press **Home** icon to exit and enter main menu page.



## 5. Intercom Function

1. **Intercom by namelist:** User in one apartment can call other apartments in the system. Touch  **Intercom** item on main menu page, then touch  **Intercom by Namelist** icon (the namelist will be created automatically by the system). Select a name on the screen then touch  **Dial Number** icon to call. Press  /  icon to enter last/next name list page. (Touch  **Dial Number** icon again to redial)

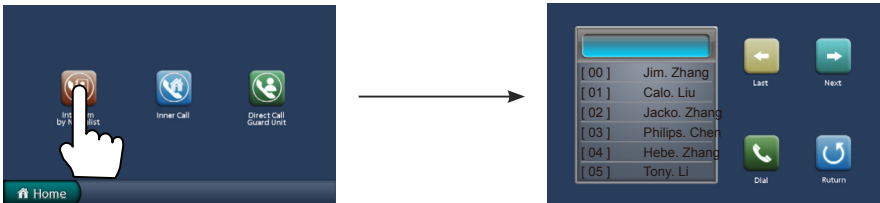

2. **Inner Call:** If multi slave monitors are installed in the same apartment, select Inner Call, all the other Monitors will ring at the same time, whichever Monitor answers the call, conversation is started. and the other monitors will stop ringing at the same time.
3. **Direct Dial Guard unit:** A Monitor can be assigned as Guard Unit Monitor; when the Guard Unit Monitor answers the call, conversation with the guard person is started..

## 6. Picture Memory

Note: the picture memory function will be activated only when the system connect SC6M module, otherwise, this function is unvalid in normal. For more information, please refer to SC6M user instruction in detail.

### Picture Recording

Both Auto-Recording and Manual-Recording are available. and Auto-Recording is default. If receive a call, after 3s, the monitor will record one picture for each calling automatically. Or you can touch **Capture** icon to record the visitor's image manually when the monitor is in monitoring or calling.

## Picture Playback

Touch **Memory Playback** icon on main menu, the recorded pictures will be played on full screen, please note that the recorded pictures can not be deleted on monitor directly.



## 7. Staircase Light

Note: the staircase light function will be activated only when the system connect light via SC6M module, otherwise, this function is unvalid in normal. For more information, please refer to SC6M user instruction in detail.

On main menu page or in monitoring,touch **Light** icon to open the staircase light, the staircase light will be turned off automatically.

## 8. Basic Setup Instructions

### Ring Tone Settings

Touch **User Setup** item on main menu page to enter setup page.Touch **Door Station Call Tone**, **Inercom Call Tone** or **DoorBell Tone** item, There are 12 pieces ring tones can be selected.touch a ring tone you want, then touch  icon to save the setting and exit.(touch  icon to cancel the setting and return last page.

**Door Station Call Tone**:set the ring tone calling from outdoor station.



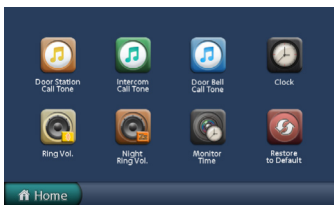

**Intercom Tone**:set the ring tone calling from other apartments.

**DoorBell tone**:set the ring tone calling from door bell.



## Ring Volume and Night Ring Volume Setting

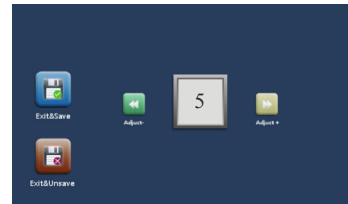
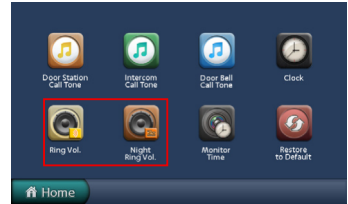

You can set a ring volume for day time and night time individually, 6:00 AM~18:00 PM is the day time and 18:00 PM~6:00 AM is the night time by default,if you don't want to be disturbed at night,you can set the night ring volume to 0.

Touch **User Setup** item on main menu page to enter setup page,then touch **Ring Volume** or **Night Ring Volume** item. then touch  /  icon to increase / decrease the value; After finish, touch  icon to save and exit.(touch  icon to cancel the setting and return last page)





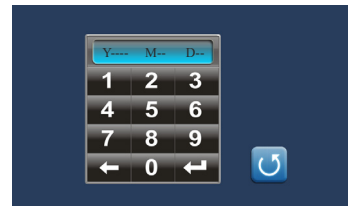

## Date and Time set

Touch **User Setup** item on main menu page to enter setup page, then touch **Clock** item, input digitals by pressing the digital keypad. Y->Year, M->month, D->Date, W->week, H->Hour, M->Minute, S->Second.

Press  icon to cancel the setting location,and press  icon to save. Settings will be performed immediately, press  icon to return last page .  
Note: the date and time setting is valid only when the system connect SC6M module.



## Monitor Time settig

Touch **User Setup** item on main menu page to enter setup page, then touch  **Monitor Time** icon to enter monitor time setting page.  
Input digitals by pressing the digital keypad, setting range is 6~600. press  icon to cancel the setting location,and press  icon to save. Settings will be performed immediately, press  icon to return last page .

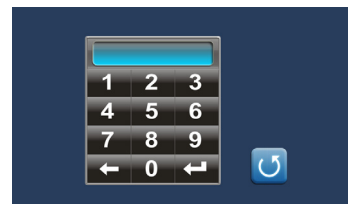

## Screen and Volume Adjustment

During monitoring or talking state, touch  **Adjust** icon, the Adjust page will be displayed.

1. The Scene mode selection: Total 4 screen modes can be selected in sequence: **Normal**, **User**, **Soft** and **Bright**. Whenever you modify **Brightness** or **colour**, **Scene** item will be set to **User** mode automatically.
2. The **Brightness** item is for the image quality setting, adjust the value to get the best image you like.
3. The **Talk Volume** item is for talking volume adjustment.
4. Note that all the modifications will be performed immediately after the operation. Touch  icon to exit the adjust page.



## Restore to Default

The restore to default function allows the user to recover the settings to factory setting. Note that the restore to default operation will not change the setting and datas.

Enter main menu page, then touch **User Setup** icon to enter the setting page, press Restore to default item, the default settings will be loaded. press **Home** icon to return to home screen page.

## 9. Monitor Parameter Setting

### How to enter the installation setting page



1. Touch  icon on main menu page.

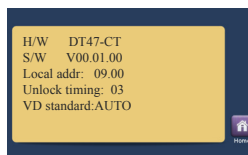

2. Touch  **UNLOCK** button and hold for 2s.



3. A digital keypad will be shown.

## How to set the monitor as a Guard Monitor

A Monitor can be assigned as Guard Unit Monitor; when the Guard Unit Monitor answers the call, conversation with the guard person is started.  
The code number of 8004 is used to set the monitor as a guard unit monitor and 8005 is used to cancel this function.

## How to set the slave monitor address



Maximum 4 monitors can be connected in one apartment, one master monitor together with 3 slave monitors, so you should set the address correctly. (note: must have one monitor to be set as master monitor)

The code of 8000 is used to set the master monitor.

The code of 8001 is used to set the first slave monitor.

The code of 8002 is used to set the second slave monitor.

The code of 8003 is used to set the third slave monitor.

Note: touch  button to cancel the input, touch  to save the settings.

## How to set date and time format

The system offers two methods of date and time.

The code number of 8008 is used to set the date format as month/date/year

The code number of 8009 is used to set the date format as date/month/year

The code number of 8012 is used to set the time format as 12 hour system

The code number of 8013 is used to set the time format as 24 hour system

## How to set the monitor panel on

In default mode, when receive a calling, the master and slave monitors will ring at the same time, and just the master monitor can display the image while the slave monitors can not. But the settings can be changed, you can set the master monitor and all the slave monitors to panel on at the same time when receiving a call, just input the code number of 8006 on each slave monitor.

Press call button  
on door station



When receiving calling, all monitors can display the image at the same time



Master monitor



#1st slave monitor



#2nd slave monitor



#3rd slave monitor

## How to set the unlock parameter

### Unlock mode:

There are two unlock modes: 1.power-on- to-unlock type:unlock mode=0(by default)  
2.power-off-to-unlock:unlock mode=1.

The code number of 8010 is used to set the unlock mode to 0

The code number of 8011 is used to set the unlock mode to 1

### Unlock time:

The unlock time can be changed by yourself at any time.it can be set from 1 to 9 seconds.  
The code number from 8021 to 8029 are used to set the unlock time to 1~ 9 seconds.

## How to set the user code for the monitor

Each monitor should be assigned an address in the system, total 32 addresses can be configured, the code number of 8200 to 8231 is used to controlled the address of 00 to 31. Please refer to the following table.

8200	Code=0	8211	Code=11	8222	Code=22
8201	Code=1	8212	Code=12	8223	Code=23
8202	Code=2	8213	Code=13	8224	Code=24
8203	Code=3	8214	Code=14	8225	Code=25
8204	Code=4	8215	Code=15	8226	Code=26
8205	Code=5	8216	Code=16	8227	Code=27
8206	Code=6	8217	Code=17	8228	Code=28
8207	Code=7	8218	Code=18	8229	Code=29
8208	Code=8	8219	Code=19	8230	Code=30
8209	Code=9	8220	Code=20	8231	Code=31
8210	Code=10	8221	Code=21		

## 10. Specification

- Power supply for indoor monitor: • DC 24V •
- Power consumption: • Standby 38.4mA; Working 320mA
- Monitor screen: • 7 Inch digital color LCD
- Display Resolutions: • 800\*3(R, G, B) x 480 pixels
- Video signal: • 1Vp-p, 75Ω, CCIR standard
- Wiring: • 2 wires, non-polarity
- Dimension: • 139(H) x 212(W) x 15(D) mm

## 11. Precautions

- 1) All components should be protected from violence vibration. And not allow to be impacted, knocked and dropped.
- 2) Please do the cleanness with soft cotton cloth, please do not use the organic impregnant or chemical clean agent. If necessary, please use a little pure water or dilute soap water to clean the dust.
- 3) Image distortion may occur if the video monitor is mounted too close to magnetic field e. g. Microwaves, TV, computer etc.
- 4) Please keep away the monitor from wet, high temperature, dust, caustic and oxidation gas in order to avoid any unpredictable damage.
- 5) Must use the right adaptor which is supplied by the manufacturer or approved by the manufacturer.
- 6) Pay attention to the high voltage inside the products, please refer service only to a trained and qualified professional.



---

The design and specifications can be changed without notice to the user. Right to interpret and copyright of this manual are preserved.