

*Since 1968*

**COMMAX**  
SmartHome & Security

# User Manual

Video Door Phone CDV-40N



[www.commax.com](http://www.commax.com)

**COMMAX Co.,Ltd.**



- Thank you for purchasing COMMAX products.
- Please carefully read this User's Guide (in particular, precautions for safety) before using a product and follow instructions to use a product exactly.
- The company is not responsible for any safety accidents caused by abnormal operation of the product.



# Table of contents

1. Greetings .....	1
2. Warnings and caution .....	2
3. Part names and functions.....	4
4. Operating .....	5
5. Installation .....	7
6. Wiring.....	8
7. Part list.....	9
8. Miscellaneous.....	9
9. Specifications .....	9



## 1. Greetings

- Thank you very much for choosing COMMAX.
- Please read this manual carefully before you use the product.



## 2. Warnings and caution

Please follow the things described below in order to prevent any danger or property damage.

	<b>Warning</b>	It may cause a serious damage or injury if violated.
	<b>Caution</b>	It may cause a minor damage or injury if violated.

	Prohibition.
	No disassembly
	No touch
	Must follow strictly.
	Shows plugging out the power cord without an exception
	Shows the warning and caution for an electric shock.
	Shows the warning and caution for a fire.

### Warning

#### Power & Installation

Please don't use several products at the same time on one power socket.

- It may cause a fire due to an abnormal overheating.

Please don't bend the power cable excessively or it may cause an electric shock.

- fire when using a damaged power cable.

Please don't handle the power cable with a wet hand.

- It may cause an electric shock.

Please plug out the power cable from the socket when not using it for a long period of time.

- It may shorten the product lifespan or cause a fire.

Please don't install the product in the place where there is much oil, smoke or humidity.

- It may cause an electric shock or fire.

Please don't install the product with the lightning and thunder.

- It may cause an electric shock or fire.

Please don't use and connect this product with other products with different rated voltage.

- It may cause a disorder or fire.

When installing the product that generates heat, please install the product away from the wall (10cm) for the ventilation.

- It may cause a fire due to the increased internal temperature.

## ! Warning

### Cleaning & Use

Please don't disassemble, repair or rebuild this product arbitrarily (please contact the service center if a repair is needed).

- It may cause an electric shock or fire.

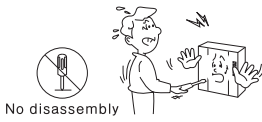

If an abnormal sound, burning smell or smoke is coming out of the product, please plug out the power cable and contact a service center.

- It may cause an electric shock or fire.

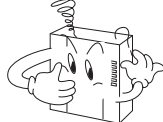

Please don't insert any metallic or burnable materials into the ventilation hole.

- It may cause an electric shock or fire.

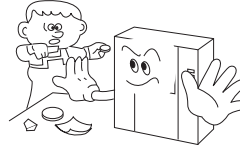

Please use only the designated batteries for the products of using DC power.

- It may cause an electric shock or fire.



## ! Caution

### Power & Installation

Please plug the power cable firmly into the inner end

- It may cause a fire.

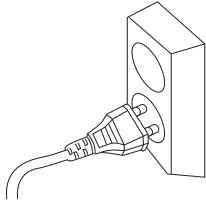

Please hold the plug tightly when unplugging the power cable (a part of the copper wire may be disconnected if the grabbing is only made on the cord when pulling out the cable).

- It may cause an electric shock or fire



When connecting the power cables after cutting the cable, please install the product with power off

- It may cause an electric shock or fire

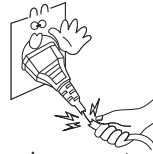

When installing the product, please fix it firmly while using the wall-mounting unit and screws.

- It may cause an injury from the falling object.

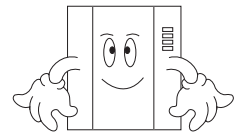

Please be careful when using an AC circuit breaker since there is a possibility of an electric shock.

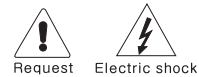
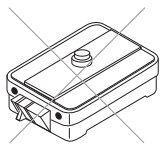

Please check the use voltage and current for the DC-only products and use the appropriate rectifier.

- It may cause a fire.

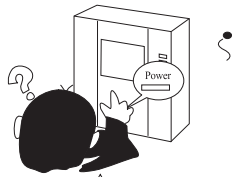

Please avoid direct rays of the sun or heating devices at a time of installation.

- It may cause a fire.

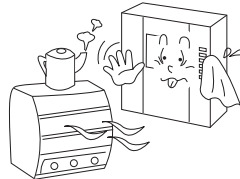

Please don't install the product on an unstable place or small support board.

- It may cause an injury if it falls down while in use.

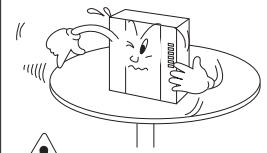

### Cleaning & Use

When cleaning the product, please rub it with a soft and dry cloth after plugging out the power cable. (Please don't use any chemical products such as wax, benzene, alcohol or cleanser.)



Please don't drop the product on the ground and don't apply a shock.

- It may cause a failure.

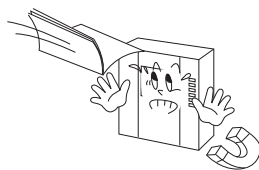

Please use the designated connection cable within the maximum calling distance designated for the product

- It may reduce the product performance.

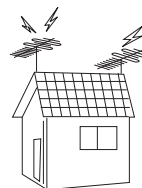



### 3. Part names and functions

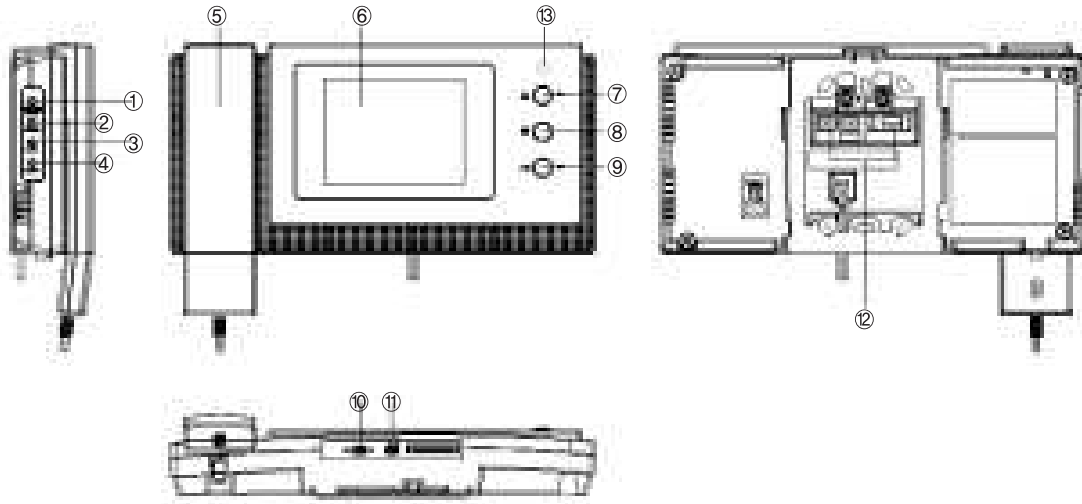

No.	Name	Description
1	BRIGHT button	Adjust brightness
2	COLOR button	Adjust color
3	CONT button	Adjust contrast
4	RESET button	Returned to default color/brightness/Contrast
5	Handset	Handset
6	Screen	LCD screen
7	Monitoring / UP button	1. Press this button to check the entrance status 2. Press this button to adjust BRIGHT / COLOR / CONT
8	Interphone call	Pick up the handset and call
9	Door open / DOWN button	1. Door release operates if you press this button during the conversation 2. Press this button to adjust BRIGHT / COLOR / CONT
10	Power On / Off	ON/OFF Switch
11	Volume control	Control incoming call volume
12	Connection / program terminal	Connecting Cameras/Interphone / Program updating
13	Power indicator	LED Light

# 4. Operating

## 1. Calling of visitor

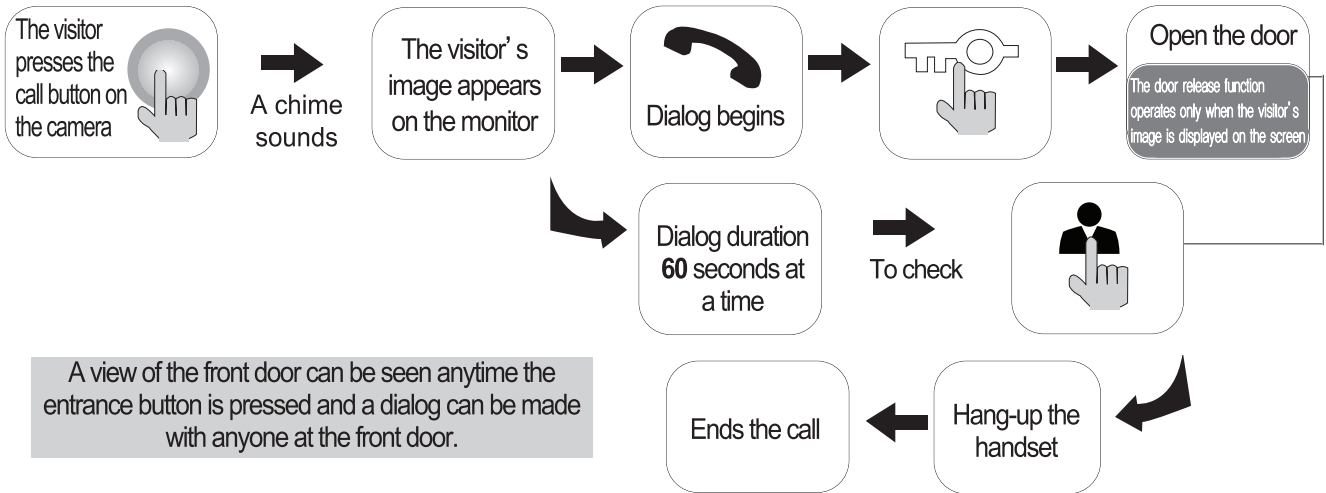

### \* In case of connecting two cameras

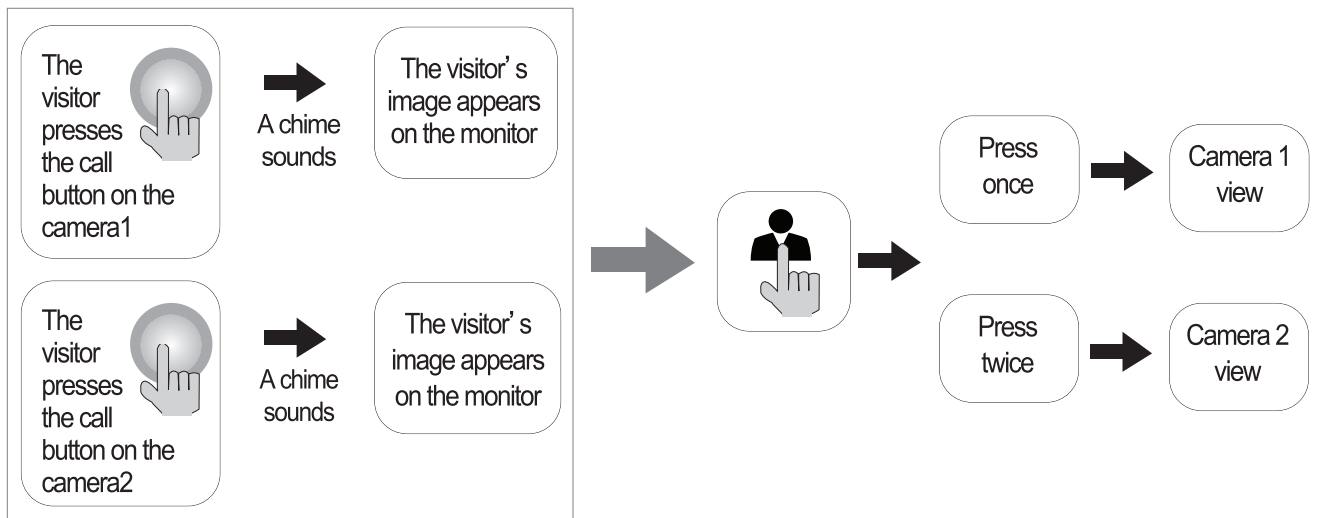

## 2. Communication with the optional Interphone

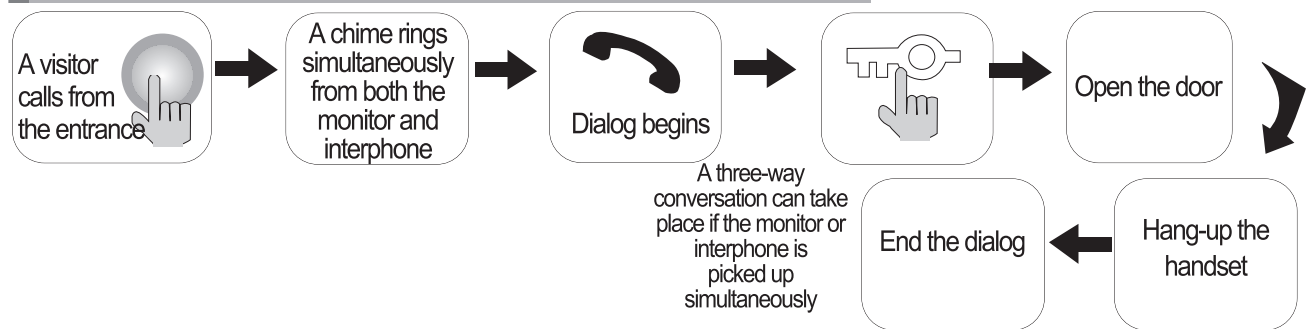

Dialog between the interphone and camera is possible only when the visitor's image is visible on the monitor screen.

### 3. BRIGHT / COLOR / CONT setting (Available only in Monitoring status)

#### 1). BRIGHT setting

- ① Press Monitoring button when the handset is hung on properly. (LED Blinking)
- ② Press BRIGHT button on the right while the screen is turned on. (Beep sound once)
- ③ Power LED is blinked as fast (BRIGHT control mode)
- ④ Adjust the Brightness as the user wants by pressing UP / DOWN button
- ⑤ Press the BRIGHT button to save the new setting when the setting is over. (Beep Beep sound)

#### 2). COLOR setting

- ① Press Monitoring button when the handset is hung on properly. (LED Blinking)
- ② Press COLOR button on the right while the screen is turned on. (Beep sound once)
- ③ Power LED is blinked as fast (COLOR control mode)
- ④ Adjust the color as the user wants by pressing UP / DOWN button
- ⑤ Press the Color button to save the new setting when the setting is over. (Beep Beep sound)

#### 3). CONT setting

- ① Press Monitoring button when the handset is hung on properly. (LED Blinking)
- ② Press CONT button on the right while the screen is turned on. (Beep sound once)
- ③ Power LED is blinked as fast (CONT control mode)
- ④ Adjust the contrast as the user wants by pressing UP / DOWN button
- ⑤ Press the CONT button to save the new setting when the setting is over. (Beep Beep sound)

#### 4). RESET (Video Status initialization)

- ① Keep pressing the reset button for 3Sec while the screen is on (Video status will be initialized)



## 5. Installation

### 1. Installation Method of camera monitor

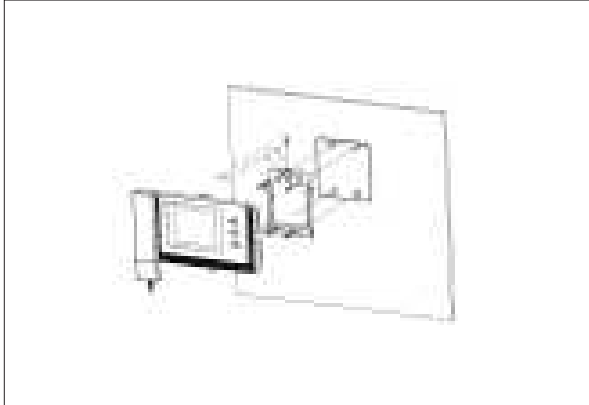

#### ⚠ Note

- ① Avoid the range of direct sunlight
- ② Recommended height is pertinent from 1450 ~ 1500mm
- ③ Avoid the installation near magnetic activity, humid temperatures and gas

### 2. Installation Method of camera

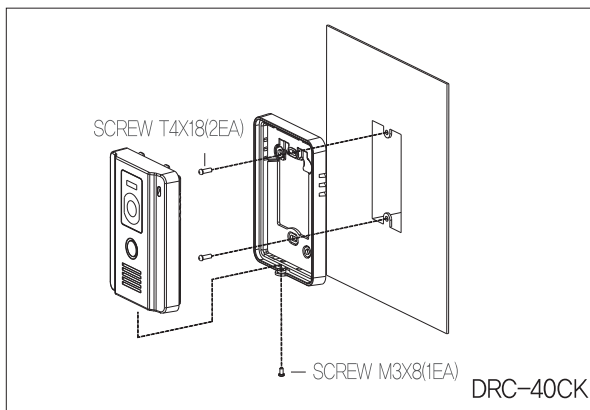

#### ⚠ Note

- ① Do not install the camera where it is exposed to Direct sunlight
- ② Keep cleaning up its lens to capture good views.

## 6. Wiring

### 1. Camera connector polarity

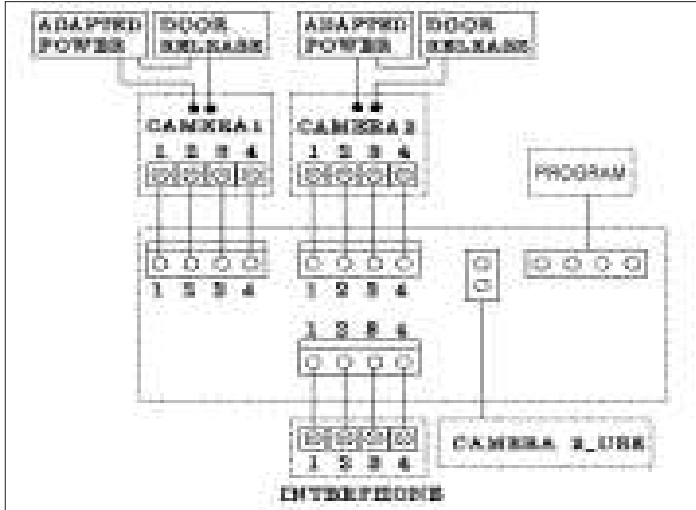

- ① Red: Voice
- ② Blue: GND
- ③ Yellow: Power (+12V)
- ④ White: Video

### 2. Wiring precautions

- 1) If high voltage cables are present in the vicinity, use a coaxial cable with metal outer casing.
- 2) If any internal wires are exposed through mis-wiring, it may cause a short and become a cause of malfunction or fire.
- 3) When connecting the monitor and camera, please make sure that the monitor power is off. (turn on the power after plugging the AC power cord into the outlet)
- 4) Attend the wiring as it is a polarity
- 5) make it short for camera 2 connector in case of installing only one camera

#### ⚠ Note

- ※ Image and call quality can be down when the monitor is expanded randomly.
- ※ Interphone call sound could be different in case additional monitor is connected with Audio line depending on the type of monitor.

## 7. Parts List

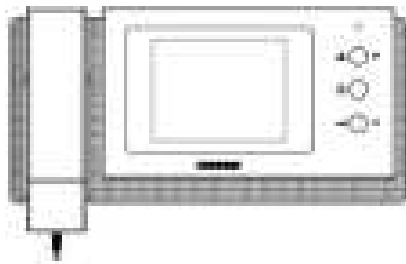

Body of CDV-40N

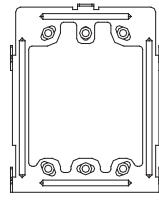

Bracket for wall mount

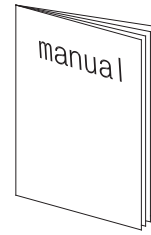

Manual

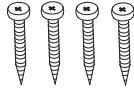

T4 X 18mm(4EA)  
Screw for wall mount



M3 X 6mm(1EA)  
Screw for body

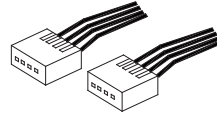

4P Connector (2EA)

## 8. Miscellaneous

- Please carefully read this User's Guide before calling service man  
After checking the entire check list, please contact customer service center.  
We will do our best to make you satisfy with our services.

## 9. Specifications

Model	CDV-40N
Rating Voltage	100-240V~, 50/60Hz
Consumption	During Operation : 10W(MAX)
Wiring method	Camera unit : 4 wires polarity, To an Interphone : 4 wires polarity
Monitor	4" LCD (10.16cm)
Communication	Full duplex (Handset)
Call tone	Door unit:electronic chime, Interphone:electronic buzzer
Screen Display	60±10sec
Distance from Camera (cable thickness)	28m(Φ0.5mm) / 50m(Φ0.65mm) / 70m(Φ0.8mm)
Working Temperature	0 ~+40°C (32°F ~ 104°F)
Dimension(mm)	249(W)X158.5X47.6(D)(Based on Max height of handset)

# **COMMAX**

**COMMAX Co.,Ltd.**

513-11, Sangdaewon-dong, Jungwon-gu, Seongnam-si, Gyeonggi-do, Korea

Int'l Business Dept. Tel. : +82-31-7393-540~550 Fax. : +82-31-745-2133

Web site : [www.commax.com](http://www.commax.com)

PM0740N00010

*Printed In Korea / 2011.03.104*